

THE NINETEEN HUNDRED NINETY-THREE



CHRYSLER LeBARON SEDAN



LeBaron LE Sedan

Chrysler LeBaron

Complementing your lifestyle, two distinctive LeBaron Sedan models now grace the Chrysler showroom: the prestigious LeBaron *Landau* Sedan and the contemporary LeBaron *LE* Sedan. Renowned for luxury, safety, quality and value, today's LeBarons uphold a heritage rich in engineering prominence.

Capture the essence of LeBaron Landau luxury with available leather-faced seating. Or, choose the sophisticated new LeBaron LE — boasting more than 45 standard features. Whatever your desire, touring pleasure will be further enhanced with the power of a 3.0-liter V6 engine* underhood.

LeBaron safety is by no means restricted to the driver-side air bag; child-protection rear door

locks come standard and four-wheel antilock brakes are available for enhanced control. Plus, all stops were pulled to guarantee first-rate quality, from parts to production.

Ensuring your utmost satisfaction, every LeBaron Sedan is backed by Chrysler's innovative Owner's Choice Protection Plan, which allows you to choose one of two comprehensive limited warranties (see details on page 17).

For all their intrinsic advantages, LeBaron Landau and LE Sedans remain remarkably affordable. That's precisely why Chrysler is at the forefront of value and **LeBaron Sedans are the perfect balance between self-indulgence and common sense.**

*Standard on Landau; optional on LE. See page 16 for details.

CONTENTS

SAFETY	
<i>The advantage of your life</i>	4
ENGINEERING	
<i>Technological advancements</i>	5
QUALITY	
<i>Details that make the difference</i>	7
CHRYSLER LEBARON LANDAU SEDAN	
<i>Timeless luxury</i>	8
CHRYSLER LEBARON LE SEDAN	
<i>New-fashioned value</i>	12
FEATURES, OPTIONS, COLORS, INTERIORS	14
SPECIFICATIONS	
<i>Standard and optional equipment</i>	15
WARRANTY INFORMATION	17

ABOUT THIS CATALOG. Since the time of printing, some of the information you'll find in this catalog may have been updated. Ask your dealer for details.

Some of the equipment shown or described throughout this catalog is available at extra cost.

Safety First

Form Follows Safety

Your safety is of paramount importance, that's why Chrysler engineers pioneered the extensive use of air bags. Every Chrysler Division passenger car Chrysler Corporation builds in the U.S. is equipped with a driver-side air bag (A). All Chrysler air bag systems are factory-certified and feature gold-plated electronic terminals to resist corrosion, humidity-sealed sensors and connectors to prevent the entry of moisture, soldered terminal grips to guarantee conductivity and neoprene-coated sewn nylon bags to protect against deterioration. The air bag, in combination with a

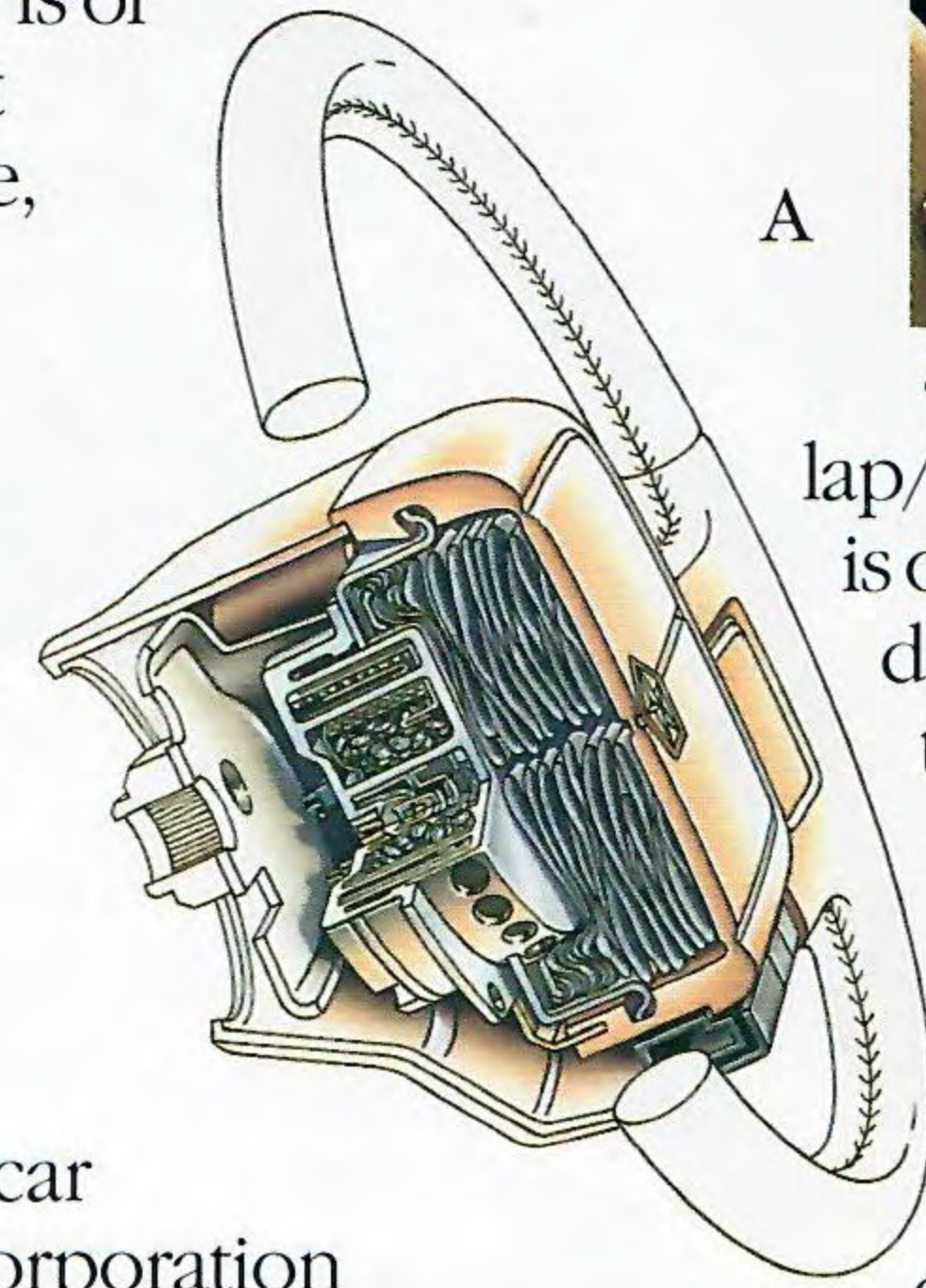

A

lap/shoulder belt, is one of the best driver protection systems available. Three-point Unibelt restraints (B) are provided for front and rear outboard passengers on all LeBarons. This safety device employs a one-piece

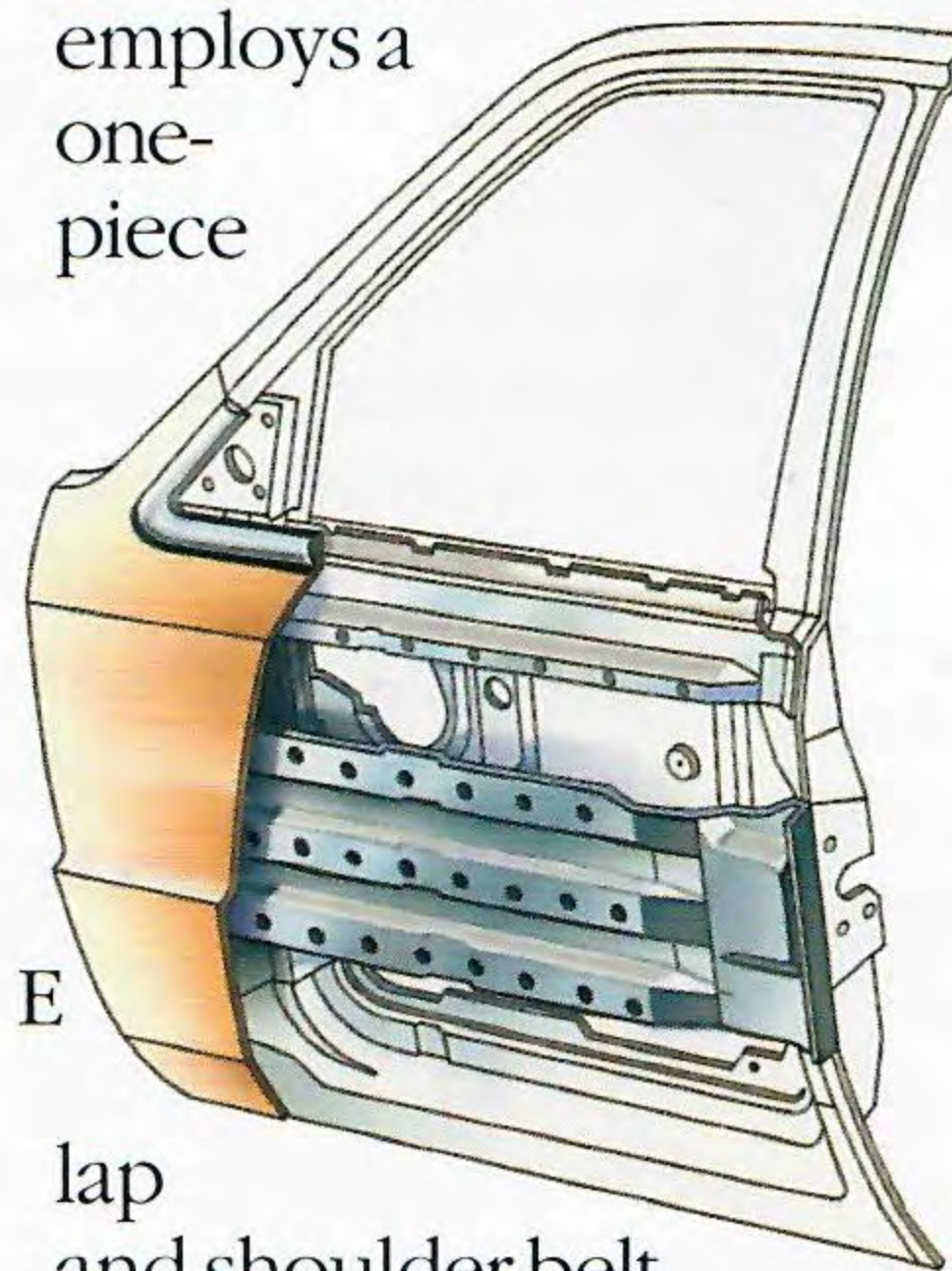

E

lap and shoulder belt — the safety belt retractor locks instantly during severe deceleration of the vehicle or in a collision. LeBaron Sedans also have child-protection rear door locks (C).

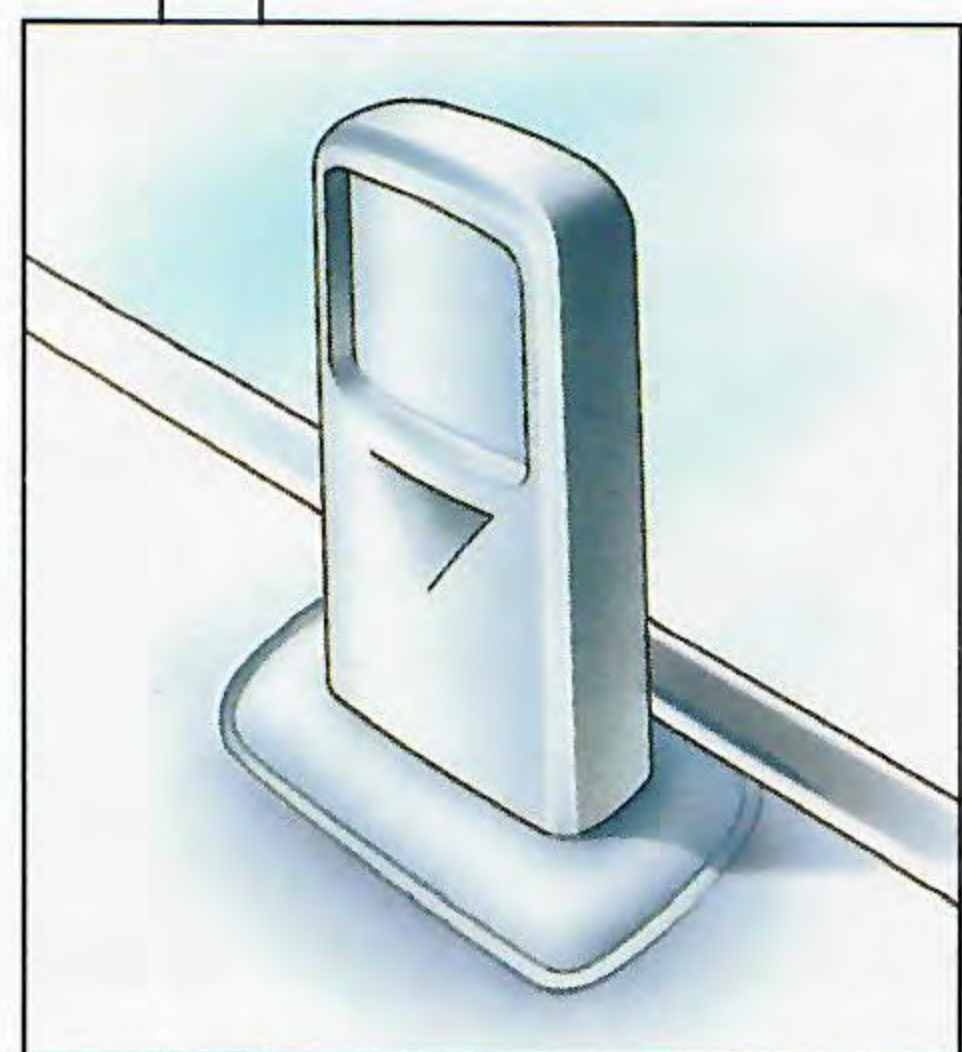

C



Simulated air bag deployment shown.

Safety That's Out Of Sight

Helping to maintain steering ability during severe braking, the special wheel speed sensors of Chrysler's available four-wheel antilock disc brake system (D) detect impending lockup, then a microprocessor selectively adjusts braking pressure up to 15 times per second. If one front wheel begins to lock, only pressure to that brake is reduced. If either rear wheel starts to lock, pressure to both rear brakes is reduced.

To better guard you in a lateral impact, every LeBaron is reinforced with steel side-door

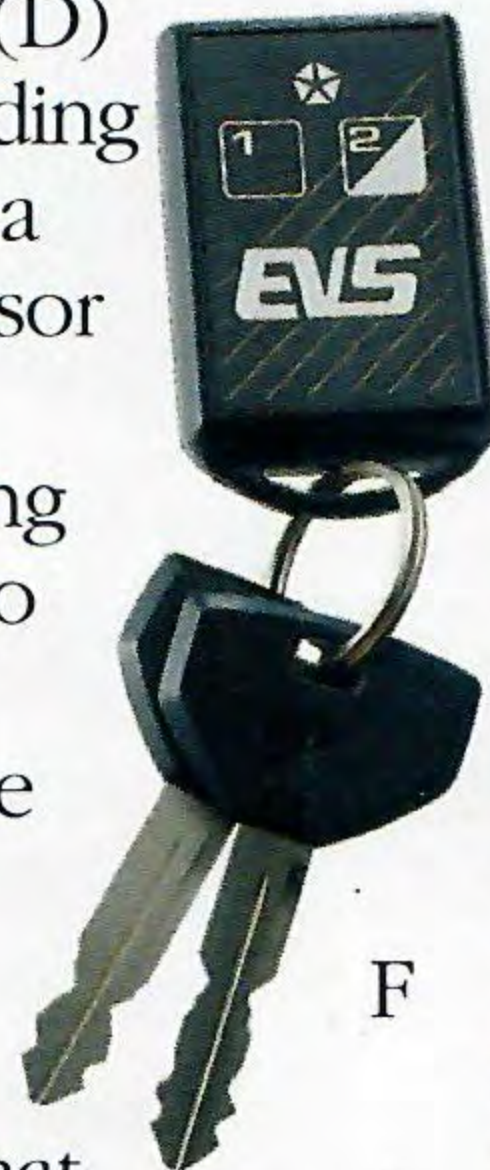

F



G

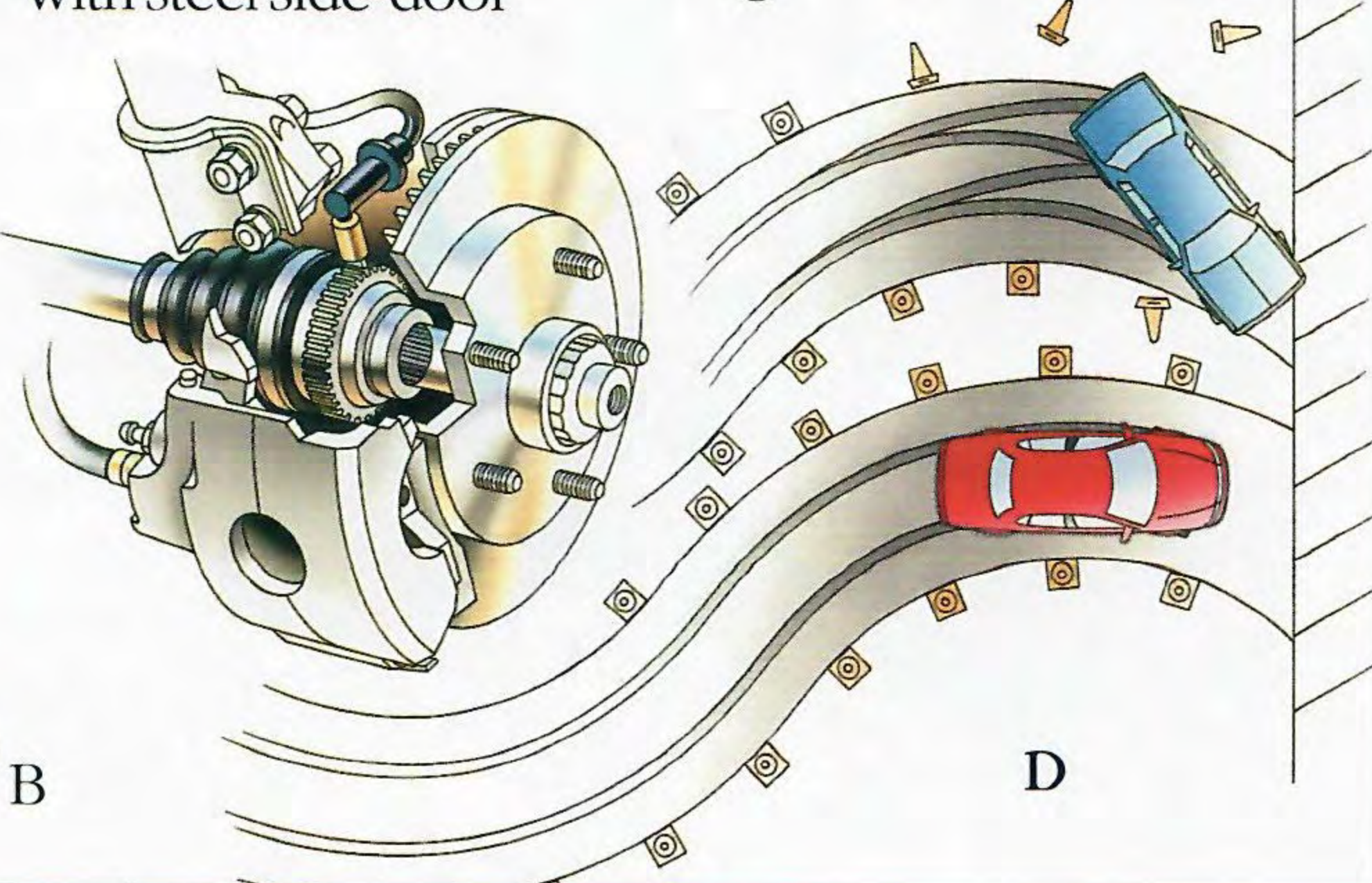

D

beams (E). And to better guard your LeBaron while you're away from it, Chrysler's Electronic Vehicle Security II System (F) is available. This dealer-installed, state-of-the-art alarm has been engineered for passive operation and includes a status monitor, last-door arming, automatic re-arming, valet override and soft-tone audible arming indicator.

Lightweight and compact, the versatile Portable Cellular Phone* (G) measures less than seven inches long and weighs in at just a fraction more than 13 ounces. It also includes a rechargeable battery and charging unit. * See page 17 for warranty details.

Quality Assurance

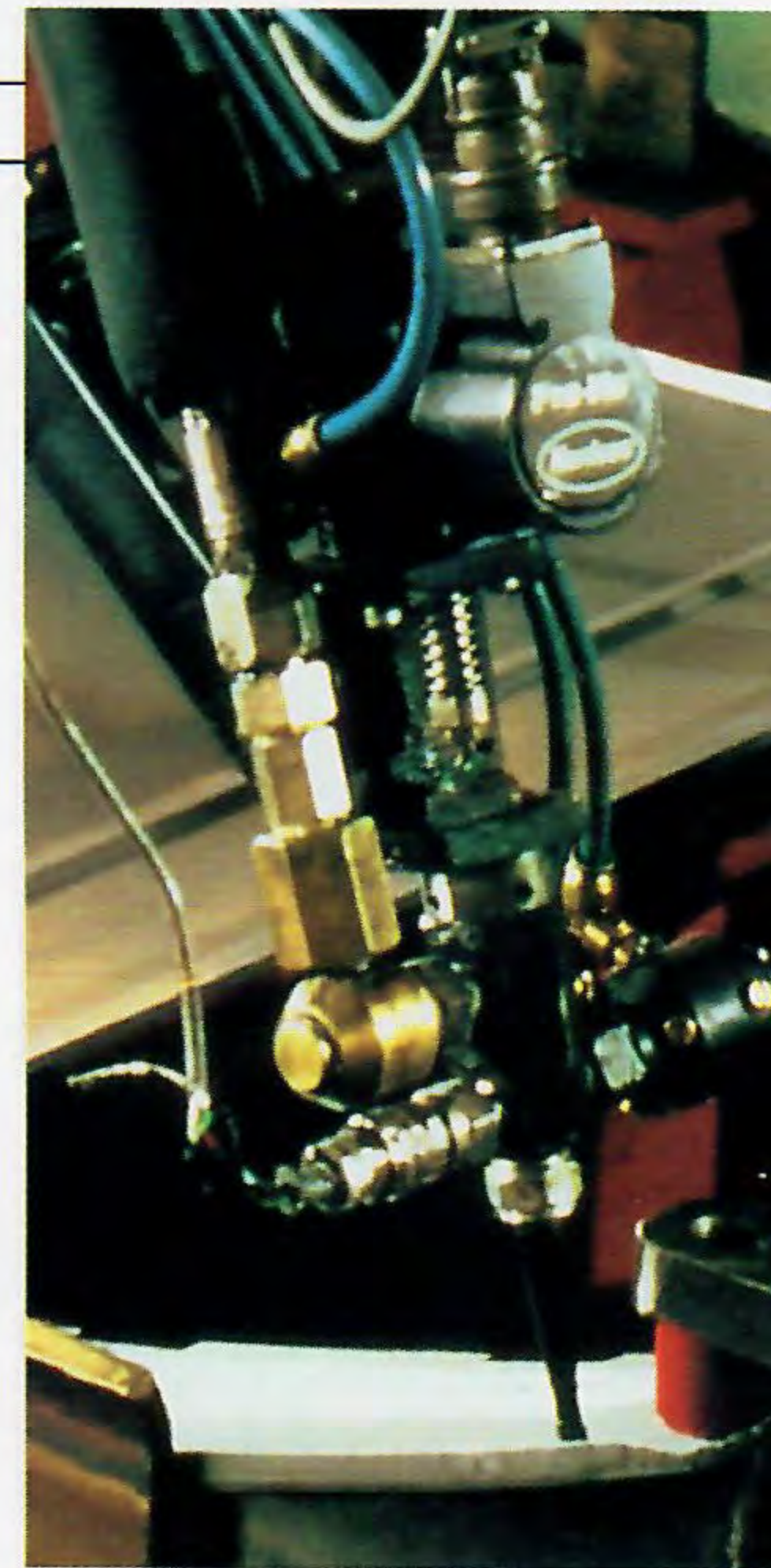

A

All Chryslers are designed, engineered and assembled with a remarkable combination of computer technology, strenuous testing and skilled craftsmanship. The goal: make every Chrysler as solid and dependable as possible.

An "anaerobic" assembly process applies a thick bead of epoxy/ resin-based cement around the entire circumference of the inner door structure. Combined with welding, this process provides reduced noise, greater strength and improved rust resistance (A).

To help improve aerodynamic design for a quiet ride and increased operating efficiency, wind tunnel testing is performed.

Better protection of automobile occupants

C



is the aim of Chrysler engineers who utilize a three-dimensional computer model in efforts to help control occupant body movements during a collision (B).

At the Chrysler test track, 50,000-mile power train endurance tests, which simulate very aggressive driving conditions, go on 24 hours a day.



D

To learn more about structural reliability, every crash test is filmed with high-speed cameras for detailed analysis (C). For durability, test engines are run at 4,000 rpm for 800 hours in dynamometer booths. A computer-operated Road Simulator creates a variety of street surfaces to determine the effect of various vibrations (D).

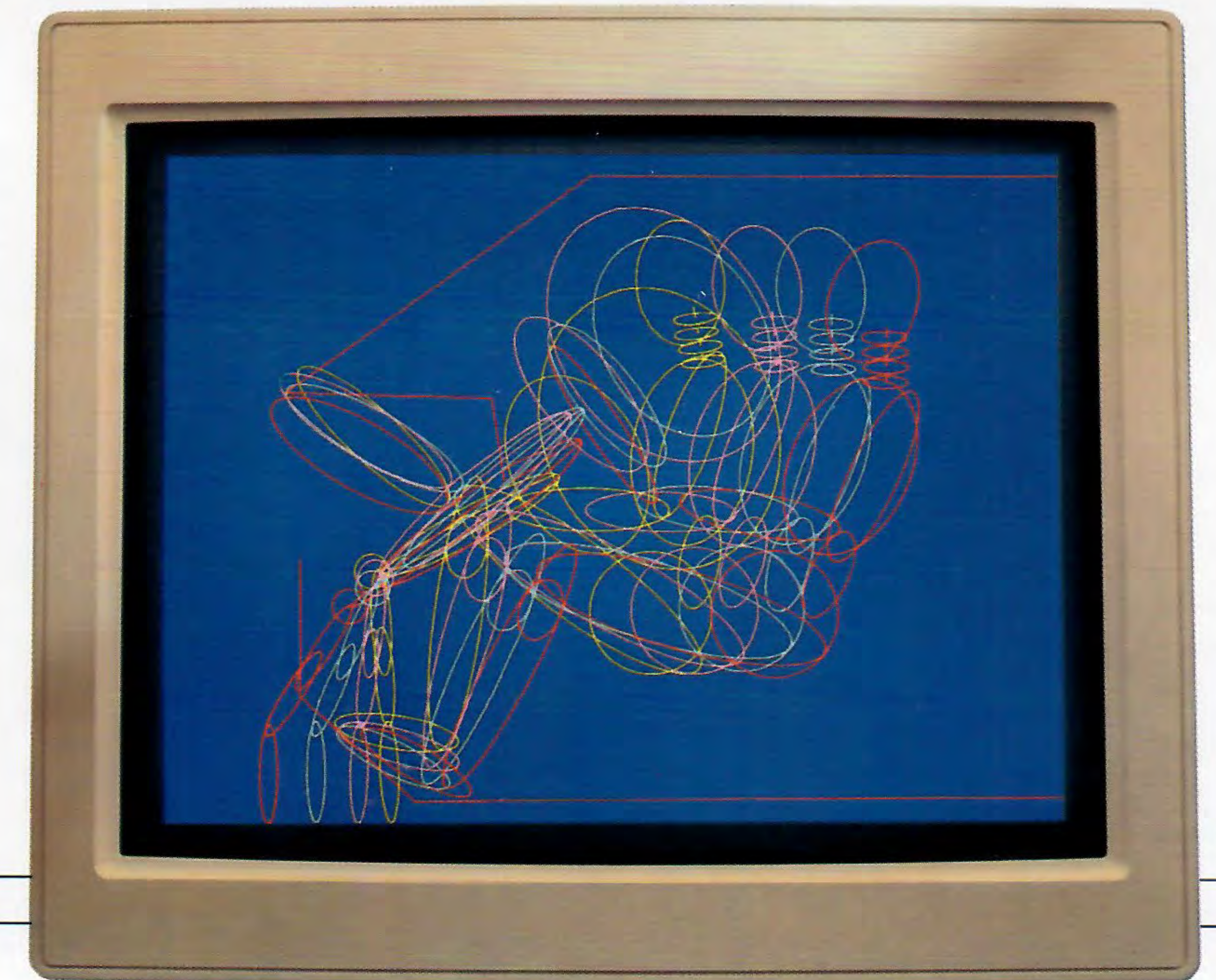

B

Leading-Edge Engineering

LeBaron Engineering Highlights

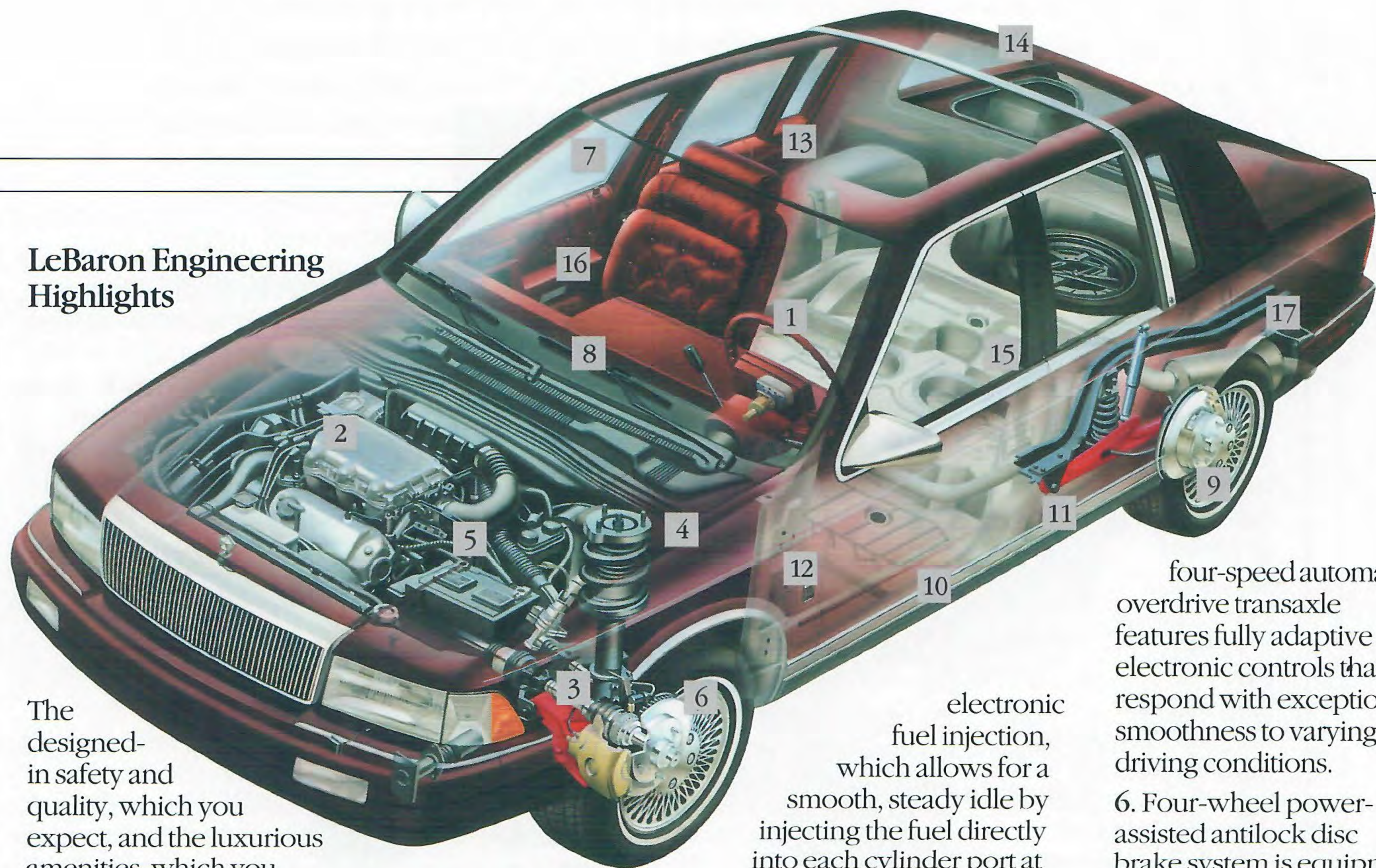

The designed-in safety and quality, which you expect, and the luxurious amenities, which you desire, are the responsibility of the people who engineer your car. Chrysler engineers work to achieve the best overall combination of components that make up every 1993 Chrysler LeBaron Sedan. Because for nearly 70

years, Chrysler Engineering has maintained a tradition of progressive automotive engineering excellence. 1. Supplemental driver-side air bag is located in a module at the center of the steering wheel.

It is designed to activate when sensors detect a frontal impact of more than 12 mph.

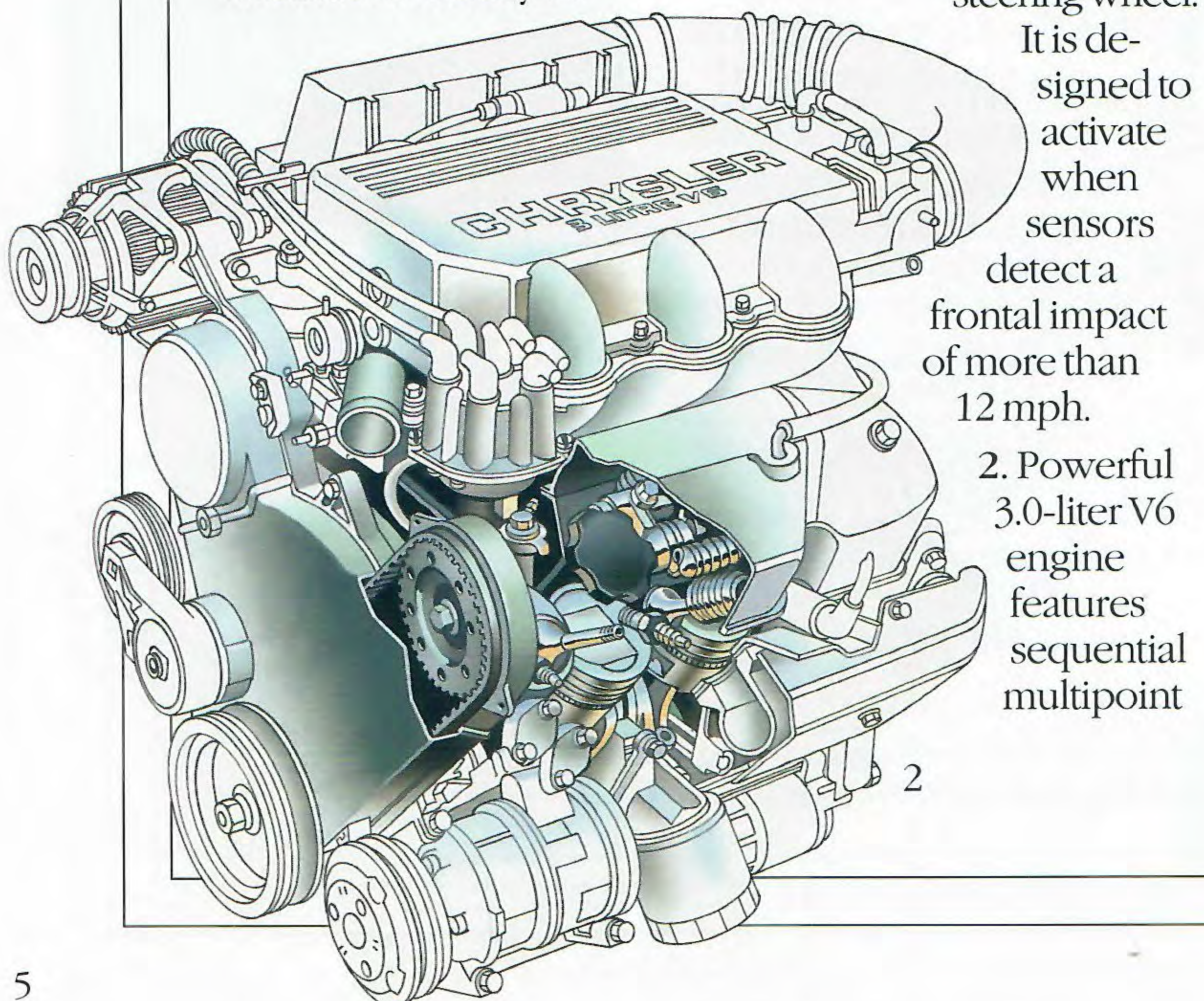

2. Powerful 3.0-liter V6 engine features sequential multipoint

electronic fuel injection, which allows for a smooth, steady idle by injecting the fuel directly into each cylinder port at the exact time it is needed. This advanced V6 power plant is equipped with a tuned intake manifold and overhead camshafts to readily deliver 141 horsepower at 5,000 rpm and 171 lb-ft of torque at 2,400 rpm. (See page 16 for details.)

3. Front-wheel drive provides superb directional stability and all-weather traction, along with maximum interior roominess and space efficiency.

4. Luxury tuned suspension utilizes position-sensitive gas-pressurized front struts and gas-pressurized rear shock absorbers for a smooth, luxurious ride.

5. Computer-controlled

four-speed automatic overdrive transaxle features fully adaptive electronic controls that respond with exceptional smoothness to varying driving conditions.

6. Four-wheel power-assisted antilock disc brake system is equipped with a microprocessor and speed sensors to prevent lockup during heavy braking, which helps prevent skidding and allows the driver to maintain steering control.

7. Heat-reflecting tinted glass windows reduce glare and help improve interior temperature control.

8. C:D® multiplex electrical system is a sophisticated communication network of microcomputers at the forefront of automotive technology. Utilizing just two wires, this patented Chrysler system allows the various electronic micro-computer modules on the vehicle to "talk" to each other. The coordinated decisions that result help

ensure occupant safety, comfort and convenience, and also improve efficiency, enhance performance and reduce emissions.

9. P195/70R14 steel-belted radial all-season whitewall tires are mated with new 14-inch Luxury wheel covers and contribute to splendid road manners. (Set of four.)

10. Galvanized steel, anti-chip protective coatings, zinc-rich primers and electroplated paints offer superior resistance to corrosion. Two applications of special Clear Coat finish produce a high-gloss lustre and protect against abrasion, weathering and chemicals. And every LeBaron is backed with Chrysler's innovative Owner's Choice Protection Plan (see page 17 for details).

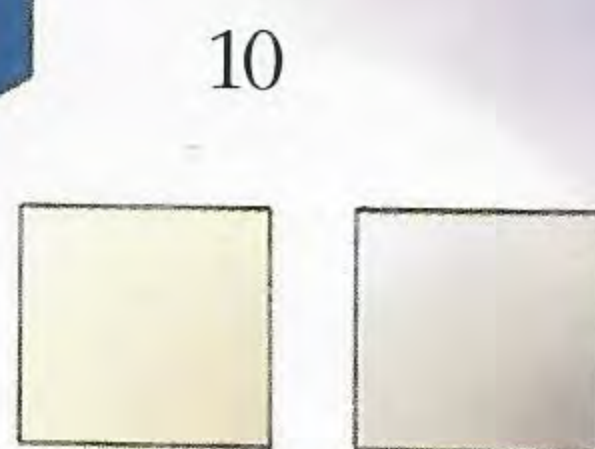
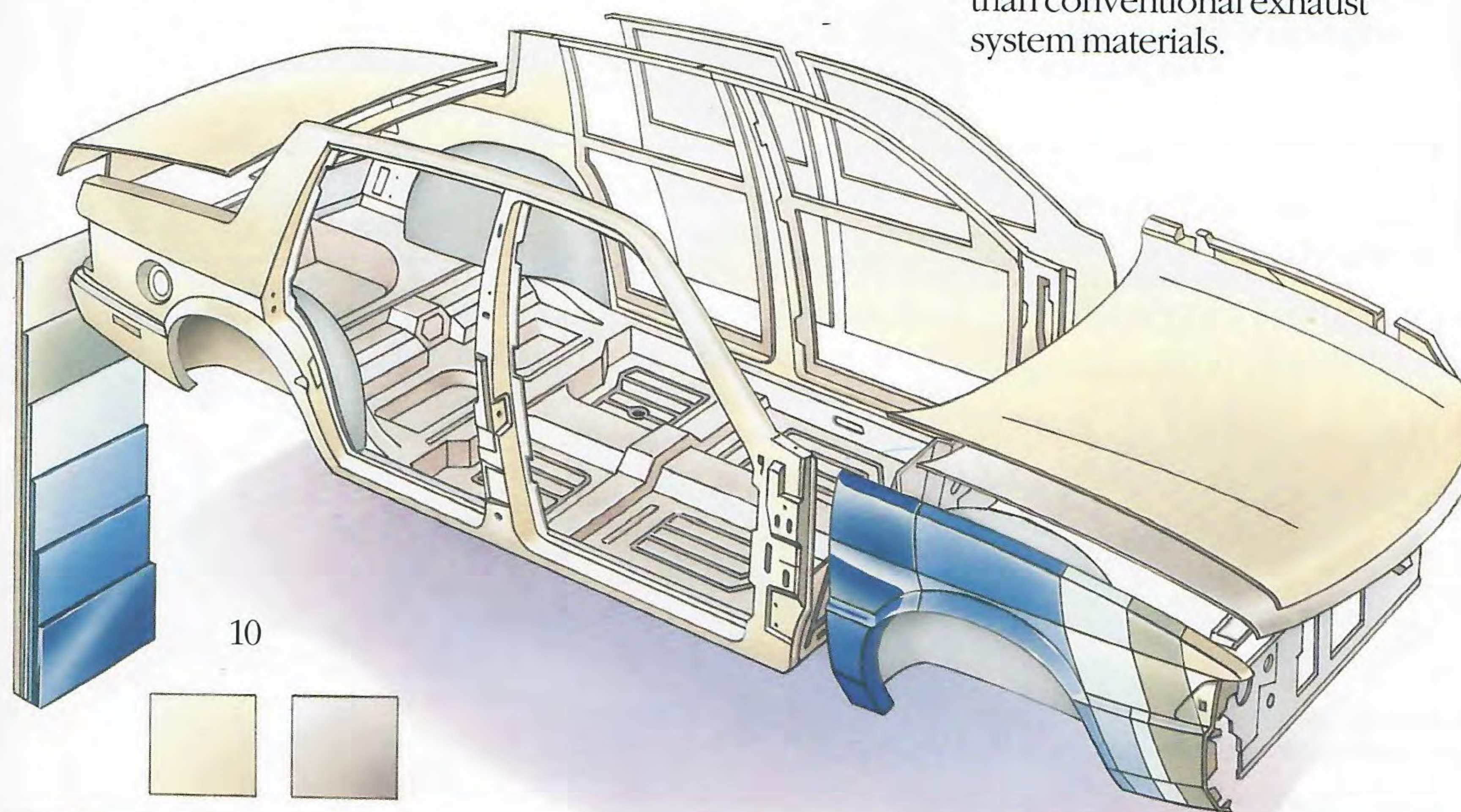

11. Unibody construction creates solid-strength passenger compartment safety and vehicular structural integrity—body sheet metal and frame members are welded into one sturdy unit.

12. Sound-deadeners, baffles, isolators, seals, silencers and extensive amounts of acoustic cavity stuffers and mastic patches have been placed strategically to ensure the highest degree of interior quietness. Noise, vibration and harshness are eliminated at their source.

13. Child-protection rear-door locks help safeguard children.

14. Quick-clear electric rear window defroster removes mist

and frost at the touch of a switch to improve rearward visibility.

15. Illuminated entry system adds security in an unlighted area.

16. Door courtesy lights help alert drivers in other cars that your door is open.

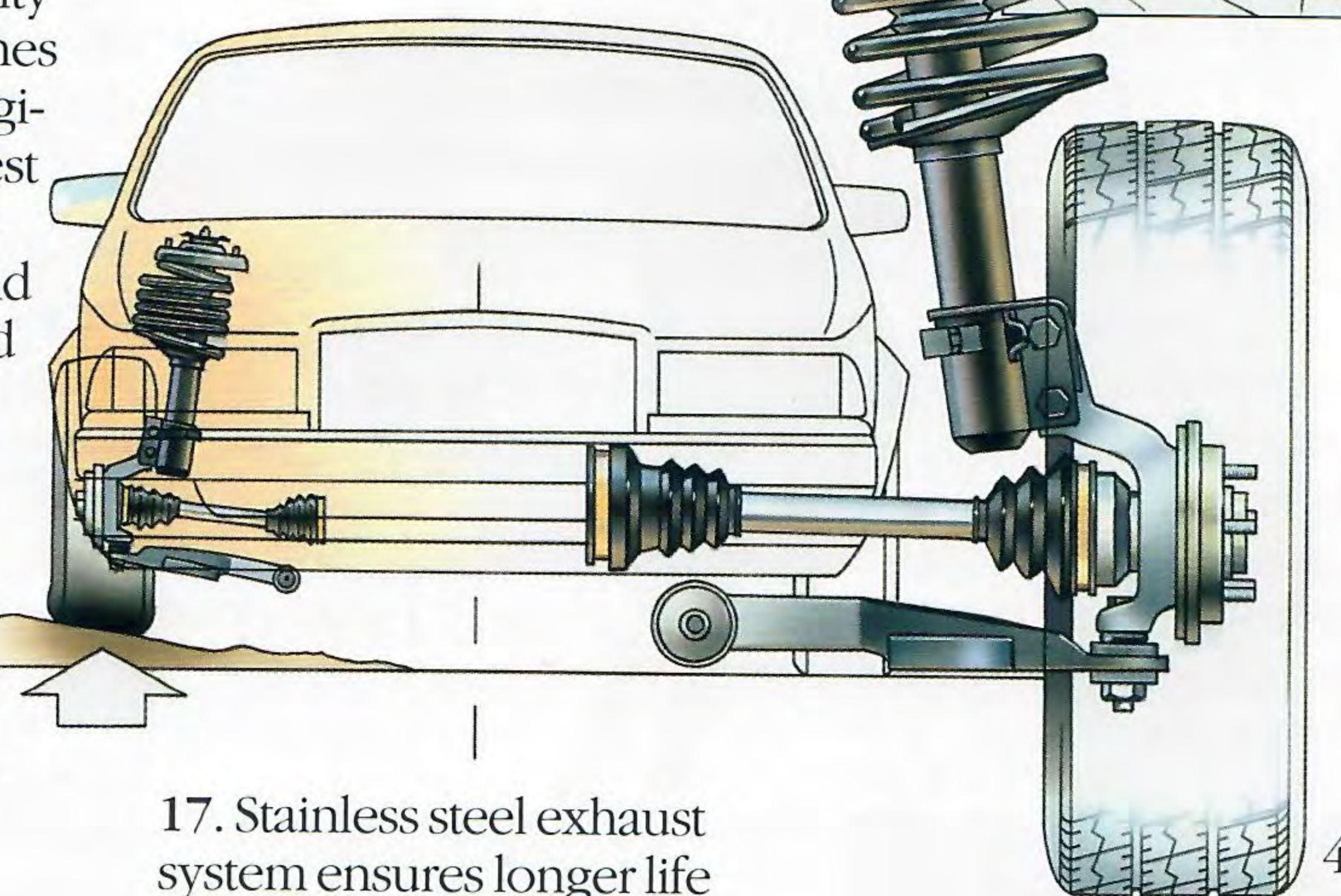

17. Stainless steel exhaust system ensures longer life than conventional exhaust system materials.

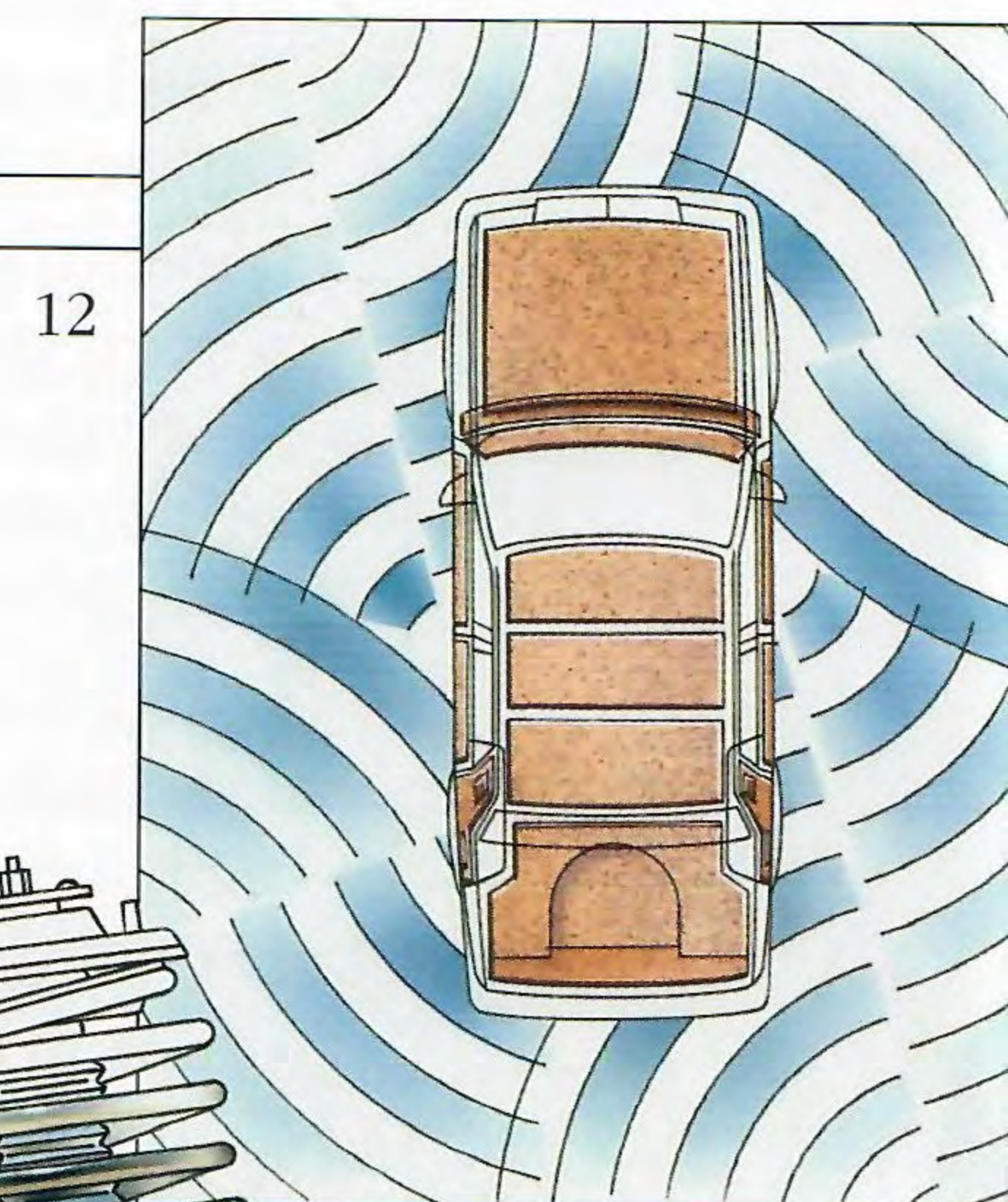

12

The availability of the equipment shown or described varies by model. See pages 15-16 for a complete listing of equipment availability and technical specifications.

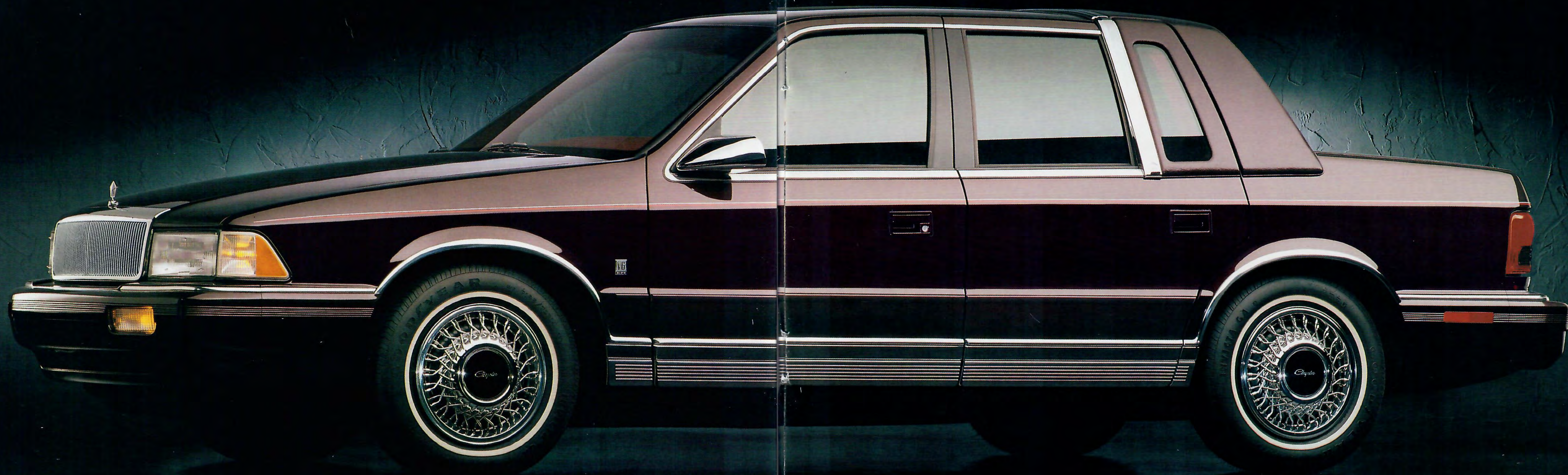

LeBaron Landau Sedan

Landau is as delightful to admire as it is to drive. From the trademark waterfall grille and available wire wheel covers to the classic padded vinyl landau roof, this luxurious sedan has all the hallmarks of elegance. Bright trim, two-tone pinstripes, even

the new full-width taillights accentuate its finely sculpted lines. But good looks alone won't get you far. Landau's computer-controlled four-speed automatic overdrive transaxle functions like clockwork in combination with an inspired



New taillight treatment

3.0-liter V6 engine,* which wields ample passing power. And whether you're going on a vacation or simply going shopping, LeBaron's well-mannered suspension always delivers a smooth, confident feel and quiet ride.

*See page 16 for details.



Available leather-faced seating

LeBaron Landau Sedan

Imagine yourself behind the wheel of a Landau... Durable leather-faced seats are available to provide you and your guests with coveted comfort. Driver-side lumbar support allows for adjustments as you see fit, and a convenient steering

column-mounted shift lever creates extra room up front to stretch. Displaying the clarity of digital speedometer and odometer readouts, Landau's available electronic instrument cluster also includes a precise travel trip computer. New



Available electronic instrumentation

woodgrain appliques and door-mounted courtesy lights are standard Landau luxuries, as are air conditioning, an AM/FM stereo radio with cassette tape player, and an advantageous rear folding center armrest.

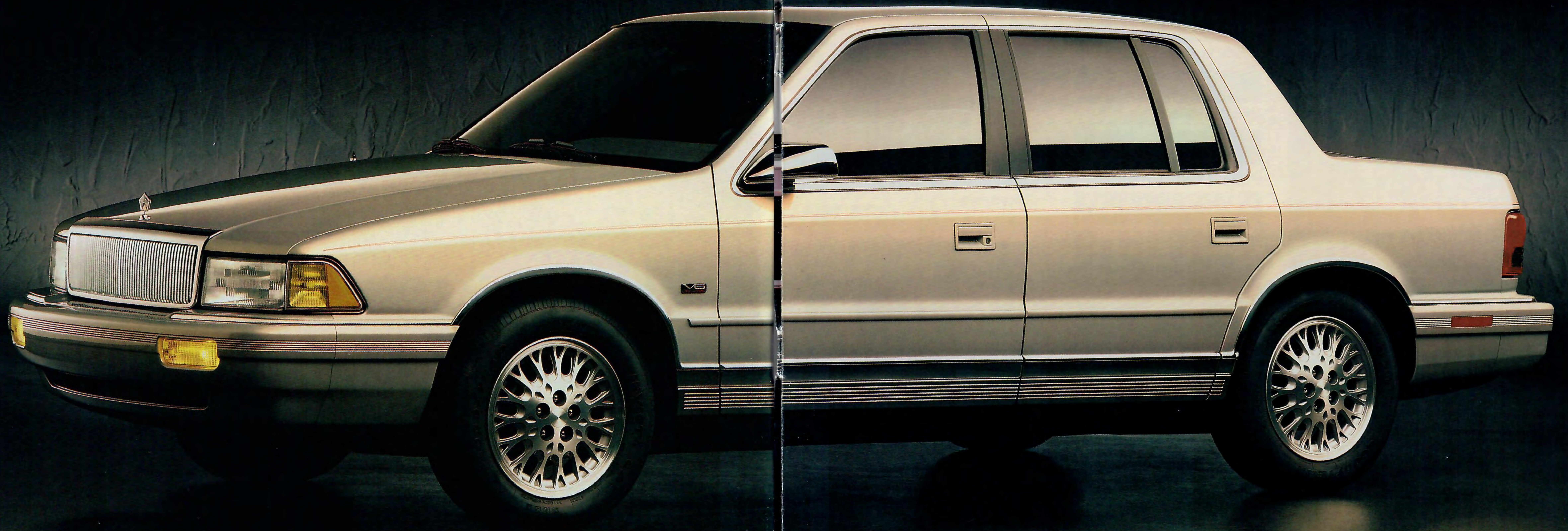

LeBaron LE Sedan

One word sums up the new LE Sedan: *Value*. With more than 45 premium features standard, this stylish LeBaron will satisfy the most discerning tastes. Cloth front bucket seats are fittingly supportive and the 55/45 split fold-down rear

seatback makes transporting bulky items a snap. Electronic speed controls are mounted handily on the steering wheel, and the center console contains convenient cup holders. The steering column tilts, windshield wiper action is variable



Premium cloth interior

intermittent and the AM/FM stereo radio broadcasts through four speakers. For efficient get-up-and-go, LE's three-speed automatic transaxle is matched with the power of an electronically fuel-injected 2.5-liter engine.

Features And Options



Exterior Colors

Black Clear Coat^{1,2}

Bright White Clear Coat^{1,2}

Metallic Red Clear Coat¹

Aqua Pearl Coat¹

Emerald Green Pearl Coat^{1,2}

Teal Pearl Coat²

Wildberry Pearl Coat^{1,2}

Light Blue Satin Glow¹

Light Driftwood Satin Glow^{1,2}

Sapphire Blue Satin Glow^{1,2}

¹LeBaron LE Sedan.

²LeBaron Landau Sedan.

Note: Due to printing limitations, the colors shown will vary slightly from actual hues. See your dealer for accurate color chips. Clear Coat finish is standard on every 1993 passenger car built by Chrysler Corporation.

MOPAR GENUINE ACCESSORIES

Here is a partial list of the more popular Mopar accessories available for Chrysler LeBarons. See your dealer for a complete list and availability by model.

- Electronic Vehicle Security (EVS II)/Keyless Entry
- Compact Disc Changer
- Deck Lid Luggage Rack
- Ski and Bike Attachments



Standard on LeBaron Landau Sedan. Premium cloth 50/50 front bench seat with driver-side adjustable lumbar support.



Standard on LeBaron LE Sedan. Premium cloth low-back front bucket seats.



Optional on LeBaron Landau Sedan. Leather-faced 50/50 front bench seat with driver-side adjustable lumbar support. A six-way power adjustable driver's seat is required.



Optional on LeBaron LE Sedan. Premium cloth 50/50 front bench seat.

Interior Colors

Cloth

Crimson Red
Slate Blue
Champagne/Medium Champagne
Medium Quartz

Leather-Faced*

Crimson Red
Slate Blue
Champagne/Medium Champagne
Medium Quartz/Light Quartz

*Available on LeBaron Landau Sedan only.

Standard And Optional Equipment

	LEBARON LE SEDAN	LEBARON LANDAU SEDAN
Air Bag—Driver's side supplemental restraint	S	S
Air Conditioning—Manual	P ¹	S
Alternator—90-ampere	S	S
Antenna—Fixed mast	S	S
Battery—Heavy-duty, maintenance-free	S	S
Brakes—Dual hydraulic, split diagonally, power-assisted: front disc/rear drum	S	S
Brakes—Power-assisted: four-wheel disc with antilock feature	E	E
Bumper Guards—Integral, rear	—	S
Bumpers—Energy-absorbing, front and rear	S	S
Carpeting—Passenger compartment, color-keyed	S	S
Carpeting—Trunk	S	S
Cellular Phone—Portable ²	E	E
Cellular Phone—Visorphone ³	E	E
Chimes—Key-in-ignition, headlights on, seat belt reminder	S	S
Cigar Lighter	S	S
Clock—Digital: integral with all radios	S	S
Coat Hooks—Rear	S	S
Console—Center: with storage bin, armrest	S	—
Console—Overhead: compass, outside temperature readout, garage door opener storage, dual courtesy lights, storage bin	—	P
Corrosion Protection—Antichip protective coating on lower bodyside panels, extensive use of galvanized steel	S	S
Deck Lid Release—Remote: lockout feature	S	S
Defroster—Rear window: electric	S	S
Door Locks—Child-protection rear doors	S	S
Door Locks—Power	E	E
Emission Controls and Testing—Required in California, not available otherwise	E	E
Engine—2.5-liter SOHC EFI	S	—
Engine—3.0-liter OHC SMPI V6 ⁴	E	S
Exhaust System—Stainless steel	S	S
Floor Mats—Carpeted, color-keyed, front and rear	S	S
Front-Wheel Drive	S	S
Fuel Capacity (16 gallons)	S	S
Fuel Filler Cap—Tethered	S	S
Glass—Tinted: all windows	S	S
Glove Box—Locking	S	S
Headlights—Halogen: aerostyle	S	S
Hood—Counterbalanced	S	S
Hood Release—Inside	S	S
Illuminated Entry System	E	P
Instrument Cluster—Analog electro-mechanical: electric speedometer, odometer, trip odometer, tachometer; gauges for electrical system voltage, engine coolant temperature, engine oil pressure, fuel level	S	S
Instrument Cluster—Electronic: vacuum fluorescent digital displays for speedometer, odometer, trip odometer; electronic analog displays for electrical voltage, fuel, engine coolant temperature, engine oil pressure; gauge alerts for charging system, engine coolant temperature, engine oil pressure	—	E

S=Standard. E=Extra cost. Some items may also be available in Customer-Preferred™ Packages. See Customer-Preferred™ Packages and "Additional Options" for availability. P=Package only. See Customer-Preferred™ Packages for availability. ¹There are special engine cooling requirements for field-installed air conditioning. Failure to follow these requirements may invalidate warranty. See your dealer for details. ²Panasonic is the warrantor and services this product that is available as a dealer-installed option. See your dealer for a copy of the limited warranty. Restrictions apply. ³OKI Telecom manufactures, services and is the warrantor of the Visorphone[®] that is available as a dealer-installed option. See your dealer for a copy of the limited warranty. Restrictions apply. ⁴Built by Mitsubishi Motors Corporation. ⁵Landau model includes door-mounted courtesy lights. ⁶Some AM stereo broadcasting may not be compatible with this radio.

Standard And Optional Equipment

	LEBARON LE SEDAN	LEBARON LANDAU SEDAN
Insulation—Premium body sound-deadening	S	S
Lights—Map/reading, glove box, front ash receiver, cigar lighter, trunk/cargo, dome ⁵	S	S
Lights—Warning: seat belt, low fuel, brake failure, high beam, air bag readiness indicator	S	S
Message Center—Warnings for door ajar, deck lid ajar, windshield washer fluid low, lamp outage	S	S
Mirror—Interior rearview: inside day/night	S	S
Mirrors—Exterior: dual manual remote control, bright	S	S
Mirrors—Exterior: dual power, heated, bright	P	E
Mirrors—Interior illuminated visor vanity: driver and passenger	E	P
Mirrors—Interior non-illuminated visor vanity: driver and passenger	S	S
Moldings—Bumper rub strip and extensions, front and rear: body color with bright edges	S	S
Moldings—Narrow bodyside: body color	S	S
Moldings—Wheel lip, full: bright	S	S
Moldings—Wide lower bodyside cladding: bright upper with argent lower accent	S	S
Radio—AM/FM stereo cassette player, four speakers	E	S
Radio—AM/FM stereo, four speakers	S	—
Radio—Infinity [®] : AM stereo ⁶ /FM stereo with seek-and-scan, cassette player, graphic equalizer, eight speakers in four locations	E	E
Radio—Infinity [®] : AM stereo ⁶ /FM stereo with seek-and-scan, integral compact disc player, graphic equalizer, eight speakers in four locations	E	E
Seat Belts—Color-keyed Unibelts with cinching latchplate on front and rear outboard seats, lap belts on other seats	S	S
Seats—Front, premium cloth low-back buckets with reclining seatbacks and two-way adjustable head restraints	S	—
Seats—Front, premium cloth 50/50 bench	E	—
Seats—Front, premium cloth 50/50 bench with reclining seatbacks, lumbar support on driver's side and two-way adjustable head restraints, seatback map pockets and individual center armrests	—	S
Seats—Front, six-way power adjustable driver's seat	E	E
Seats—Leather-faced, including six-way power driver's seat	—	E
Seats—Rear, premium cloth, fixed back	—	S
Seats—Rear, premium cloth, split folding seatback	S	—
Speed Control—Electronic	S	S
Steering—Rack-and-pinion: power-assisted 16:1 ratio	S	S
Steering Column—Tilt	S	S
Steering Wheel—Luxury: leather-wrapped	—	P
Steering Wheel—Luxury: two-spoke	S	S
Stripe—Bodyside and deck lid	S	S
Suspension System—Luxury tuned; front: gas-charged struts, antisway bar; rear: coil springs, gas-charged shocks, antisway bar	S	S
Suspension System—Road touring	P	—

Standard And Optional Equipment (continued)

	LEBARON LE SEDAN	LEBARON LANDAU SEDAN
Tire—Spare: compact (T125/70D14)	S	S
Tire—Spare: conventional	E	E
Tires—P195/70R14 steel-belted radial black sidewall all-season touring (set of four)	S	—
Tires—P195/70R14 steel-belted radial white sidewall all-season touring (set of four)	E	S
Tires—P205/60R15 steel-belted radial black sidewall all-season touring (set of four)	P	—
Transaxle—Four-speed computer-controlled automatic overdrive	E	S
Transaxle—Three-speed automatic	S	—
Trip Computer—Mini	—	E
Vehicle Theft Security Alarm System—Dealer-installed	E	E
Wheel Covers—Luxury: 14-inch (set of four)	S	S
Wheel Covers—Wire: 14-inch (set of four)	—	E
Wheels—Cast aluminum: 15-inch (set of four)	P	—
Windows—Power	P	E
Windshield Wiper System—Deluxe intermittent	S	S

S = Standard. E = Extra cost. Some items may also be available in Customer-Preferred™ Packages. See Customer-Preferred™ Packages and "Additional Options" for availability. P = Package only. See Customer-Preferred™ Packages for availability.

Dimensions

EXTERIOR

Overall Length (in.)	182.7
Wheelbase (in.)	103.5
Overall Height (in.)	53.5
Front Track (in.)	57.6
Rear Track (in.)	57.2
Overall Width (in.)	68.1
Turning Diameter (ft)	37.0L/39.0R

INTERIOR

Front Head Room (in.)	38.4
Front Leg Room (in.)	41.9
Front Hip Room (in.)	51.7
Front Shoulder Room (in.)	54.3
Rear Head Room (in.)	37.9
Rear Leg Room (in.)	38.3
Rear Hip Room (in.)	52.0
Rear Shoulder Room (in.)	55.0
Trunk Capacity (cu ft)	14.4
Interior Volume (cu ft)	95.7

Engine Specifications

	2.5-LITER 4-CYLINDER SOHC SINGLE-POINT ELECTRONIC FUEL INJECTION	3.0-LITER V6 OHC SEQUENTIAL MULTIPOINT FUEL INJECTION ¹
Bore x Stroke (in.)	3.44 x 4.09	3.59 x 2.99
Displacement (cu in./liters)	153/2.5	181.4/3.0
Power (hp @ rpm)	100 @ 4,800	141 @ 5,000
Torque (lb ft @ rpm)	135 @ 2,800	171 @ 2,400
Compression Ratio	8.9:1	8.9:1
Fuel Type	Unleaded Regular	Unleaded Regular

¹Built by Mitsubishi Motors Corporation.

Customer-Preferred™ Packages

PACKAGE CONTENTS	LEBARON LE SEDAN			LEBARON LANDAU SEDAN	
	P	U	X	K	L
Air Conditioning ¹		•	•	S	S
Console—Overhead					•
Fifteen-Inch Cast Aluminum Wheels and P205/60R15 Steel-Belted Radial All-Season Tires (Sets of 4)			•		
Illuminated Entry/Illuminated Visor Vanity Mirrors					•
Power Door Locks		•	•		•
Power Heated Mirrors		•	•		•
Power Windows		•	•		•
Radio—AM/FM stereo with cassette			•	S	S
Road Touring Suspension			•		
Steering Wheel—Leather-wrapped					•
Wire Wheel Covers (Set of four)					•

S = Standard. • = Included in Customer-Preferred™ Package.
¹There are special engine cooling requirements for field-installed air conditioning. Failure to follow these requirements may invalidate warranty. See dealer for details.

ADDITIONAL OPTIONS — Available only with corresponding Customer-Preferred™ Packages

Brakes—Four-wheel antilock disc	E	E	E	E	E
Electronic Instrument Cluster—Mini trip computer					E
Illuminated Entry/Illuminated Visor Vanity Mirrors		E	E		P
Leather-Faced Seats/Leather-Wrapped Steering Wheel				E	E
Power Heated Mirrors/Power Windows/Power Door Locks		P	P	E	P
Power Seat—Driver's side, six-way adjustable		E	E	E ¹	E ¹
Radio—AM/FM stereo with cassette		E	P	S	S
Radio—Infinity® with seek-and-scan cassette and graphic equalizer		E	E	E	E
Radio—Infinity® with integral compact disc player and graphic equalizer		E	E	E	E
Seat—50/50 front bench		E	E	S	S
Tire—Spare: conventional		E		E	E
Tires—P195/70R14 steel-belted radial white sidewall (Set of four)		E		S	S
Wire Wheel Covers (Set of four)				E	P

S = Standard. P = Included in Customer-Preferred™ Package listed above.
E = Extra cost. Available only when corresponding Customer-Preferred™ Package is ordered. ¹Included with leather-faced seating.

Power Train Availability

ENGINE	TRANSAXLE	LEBARON LE SEDAN	LEBARON LANDAU SEDAN
2.5-Liter 4-Cylinder EFI	3-Speed Automatic, OTGR 3.02	S	—
3.0 Liter SMPI V6 ¹	3-Speed Automatic, OTGR 3.02 4-Speed Automatic Overdrive, OTGR 2.52	E	S

S = Standard. E = Extra cost.
¹Built by Mitsubishi Motors Corporation.

STANDARD SAFETY FEATURES

• Air bag (driver's side) • Antitheft ignition and steering column lock • Backup lights • Brake fluid pressure loss warning light (also serves as indicator when parking brake is applied) • Center high-mounted supplemental stoplight • Child-protection rear door locks • Combination lap/shoulder belts for driver and all outboard passengers; lap belts for center locations • Day/night rearview mirror adjustment • Double ball-joint rearview mirror mount • Dual diagonal braking system with separate brake fluid reservoirs in the master cylinder • Dual throttle return springs • Electric windshield washers/wipers with intermittent wipe feature • Energy-absorbing front and rear bumper system • Energy-absorbing front seatbacks • Energy-absorbing instrument panel • Energy-absorbing steering column • Fade-resistant ventilated power-assisted front disc brakes • Fasten seat belt reminder • Front brake lining wear detectors • Glare reduction measures for instrument panel, steering wheel and windshield wipers • Hazard warning flasher system • Headlight and wiper circuit breakers with automatic reset • Impact-actuated fuel supply shutdown relay • Inside and outside rearview mirrors • Inside hood release • Interlocking door latches • Key-left-in-ignition warning • Non-override door locks (except driver's door) • Recessed inside door release handles • Reinforced windshield header and roof • Resilient window crank knobs, if applicable • Safety-Rim wheels • Shatter-resistant glass • Side door beams • Side marker lights and reflectors • Turn signals with lane-change feature



THE OWNER'S CHOICE PROTECTION PLAN

Now you have a choice of protection plans to suit your needs. When you purchase a new 1993 Chrysler LeBaron Sedan, you can choose either of the two limited warranty plans described below.

3/36 Bumper-to-Bumper Limited Warranty

The three-year or 36,000-mile Basic Bumper-to-Bumper Limited Warranty covers the entire vehicle including power train (excludes adjustments, tires, normal wear items and maintenance). No deductible applies. Restrictions apply. See your dealer for a copy of this limited warranty.

OR

7/70 Power Train Limited Warranty

Upon expiration of the 12-month or 12,000-mile Basic Limited Warranty, coverage is extended on power train components to seven years or 70,000 miles. No deductible applies. Restrictions apply. See your dealer for a copy of these limited warranties.

7/100,000 Anticorrosion Limited Warranty

In addition, all Chrysler Corporation vehicles are covered by the 7/100,000 Outer Panel Anticorrosion Limited Warranty. Your dealer will repair or replace at no charge outer body sheet metal panels found to have developed perforation (rust-through) in normal use up to seven years or 100,000 miles. No deductible applies. See your dealer for a copy of the warranty.



We sell satisfaction.

CHRYSLER SERVICE CONTRACTS

Additional peace-of-mind protection for vehicle owners is available through optional Chrysler Service Contracts. These services are available in a variety of time and mileage combinations to meet your particular driving needs.



CHRYSLER CREDIT FINANCING

Chrysler Credit offers a variety of finance programs that can help make your new Chrysler LeBaron Sedan even more affordable. These flexible finance and lease programs can be tailored to suit your budget and your lifestyle. They include Gold Key Plus, College Graduate Plans, Gold Key Lease, Retail Financing and other special payment plans. Ask your salesperson for details.



CHRYSLER CORPORATION GENUINE PARTS

MOPAR parts are engineered by Chrysler Corporation for use in your new Chrysler LeBaron Sedan. When replacement is necessary, be sure to specify MOPAR parts. Used by professional automotive technicians worldwide.



ASK FOR A TEST TALK

For 1993, Chrysler will be offering a selection of dealer-installed/supplied cellular phones in several models to enhance the available optional equipment list. Ask your dealer for details. OKI® and Panasonic warrant and service these products. Restrictions apply. Ask your dealer for details and a copy of these limited warranties.



PHYSICALLY CHALLENGED ASSISTANCE PROGRAM

Cash reimbursement of up to \$500 for purchase and installation of adaptive driving aids or passenger equipment on new 1993 Chrysler Corporation cars, trucks or vans. For further information, contact your dealer or the PHYSICALLY CHALLENGED RESOURCE CENTER at 1-800-255-9877.

All product illustrations and specifications are based upon current information at the time of publication approval. Although descriptions are believed correct, complete accuracy cannot be guaranteed. Chrysler Corporation reserves the right to make changes from time to time, without notice or obligation, in prices, specifications, colors and materials, and to change or discontinue models. See your dealer for the latest information.

Chrysler and MOPAR are registered trademarks, and LeBaron is a trademark of Chrysler Corporation.
Buckle up for safety.



Advantage: Chrysler

A DIVISION OF THE CHRYSLER CORPORATION

